

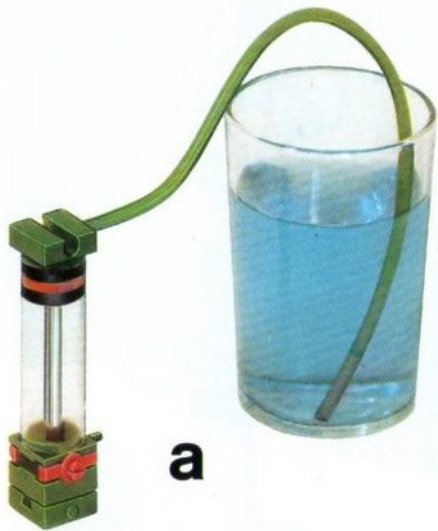

Hydraulik-Bagger
Digger
Bulldozer hydraulique
Hydraulische Bulldozer
Draga hidráulica
Spardon escavatore idraulico





a

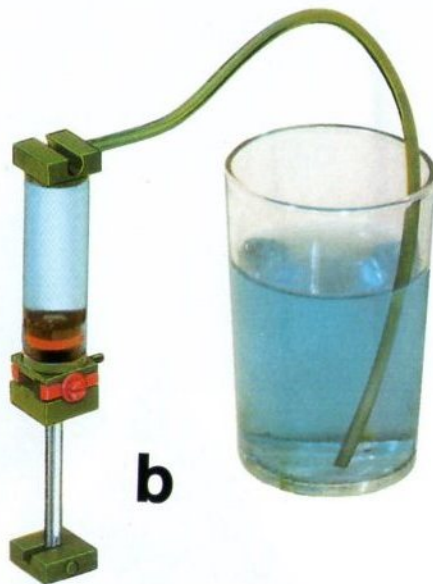

b



c



d

Bei zu großer Belastung schiebt sich die Achse durch den Kolben (s. Abb. c). Sie läßt sich wieder zurückziehen (s. Abb. d).

Overloading the piston may result in the rod being pushed through the piston (see fig. c). The rod can be pulled back without any problem (see fig. d).

Lors de fortes pressions l'axe glisse à travers le piston (figure c). Une remise en place est possible (figure d).

Wasser einfüllen, bis die Luft entwichen ist (s. Abb. a, b).

Fill up with water till no air is left inside (see step a, b).

Remplir d'eau pour éliminer l'air (voir plan de construction a, b).

Met water vullen tot de lucht geweken is (zie bouwfase a, b).

Llenar de agua hasta que haya salido todo el aire (ver dibujo a, b).

Riempire di acqua fino a quando tutta l'aria è uscita (vedi fase di costruzione a, b).

Bij te grote belasting schuift de as door de zuiger (zie afb. c). Men kan haar weer terugtrekken (zie afb. d).

Con una carga demasiado grande, el eje pasa por el pistón (ver dibujo c). Este se puede sacar otra vez (ver dibujo d).

A troppo peso l'asse so sposta nel cilindro (vedi fig. c). È possibile tirarla indietro (vedi fig. d).

Die grünen Hydraulikbauteile haben andere technische Anforderungen und Möglichkeiten als die blauen Pneumatikbauteile (fischertechnik-Kernprogramm). Deshalb sind diese Bauteile nicht untereinander austauschbar.

The green building blocks of the hydraulic kit are not interchangeable with the blue building blocks of the pneumatic kit, which is part of the fischertechnik basic programme, as the two types of blocks have been designed to satisfy different technical requirements.

Les pièces hydrauliques vertes se distinguent des pièces bleues de la boîte pneumatique (programme de base fischertechnik), elles répondent à des critères techniques différents et correspondent à d'autres applications.

De groene hydraulica onderdelen hebben andere technische eisen en mogelijkheden dan de blauwe pneumatica onderdelen (ft kernprogramma) daarom zijn deze onderdelen niet onderling omwisselbaar.

Los elementos de construcción hidráulica verdes, tienen otras exigencias técnicas y posibilidades, a la de los elementos neumáticos azules (programa base fischertechnik). Por esto, estos elementos de construcción, no son intercambiables.

Gli elementi idraulici di color verde hanno altre esigenze tecniche e possibilità degli elementi blu della cassetta pneumatica (ft-programma centrale) e quindi non possono essere scambiati tra di loro.

1

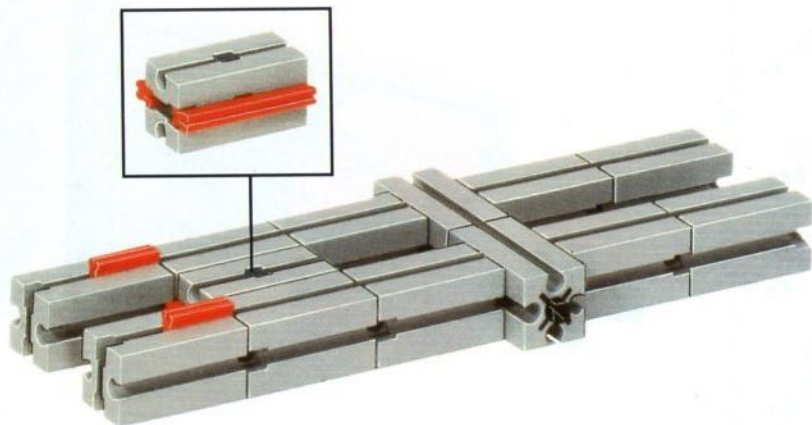
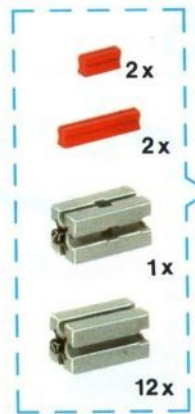

2

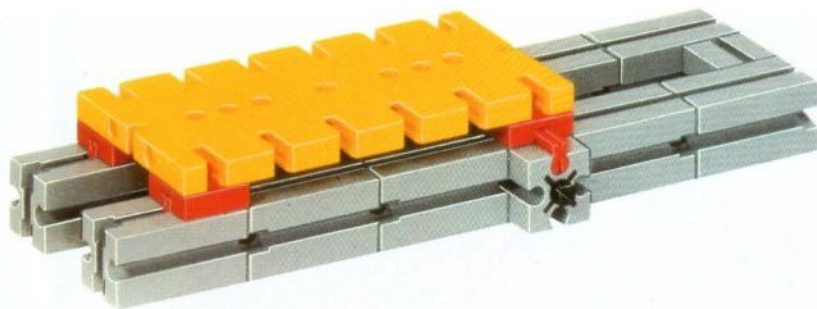
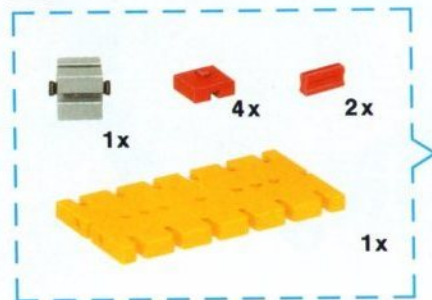

3

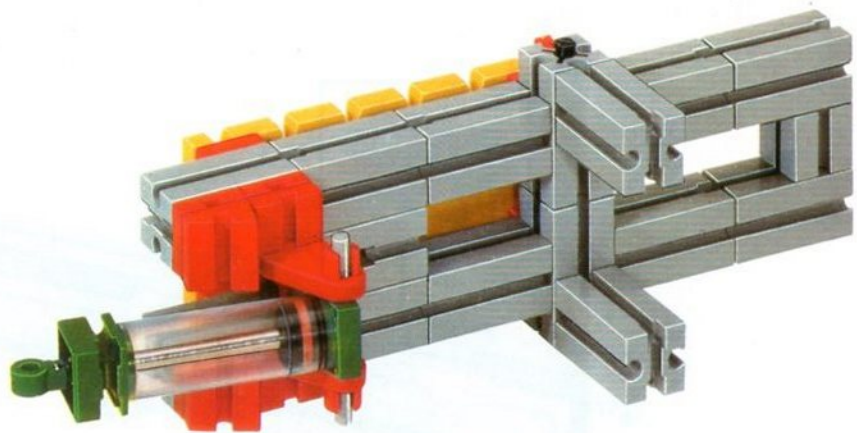
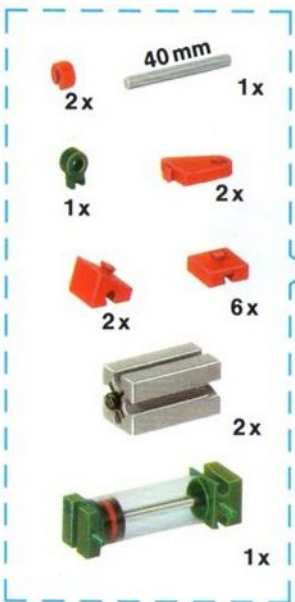

5



von unten
underside
d'en bas
van onderen
de abajo
sotto

4

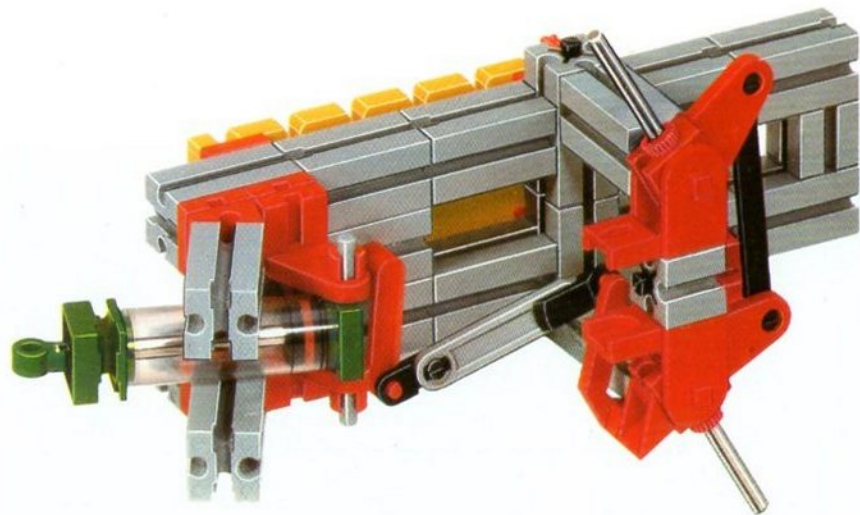
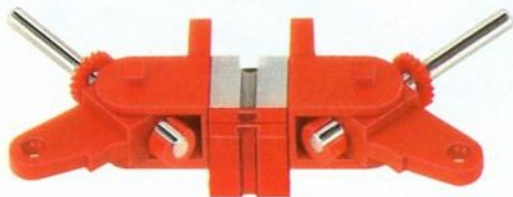

6

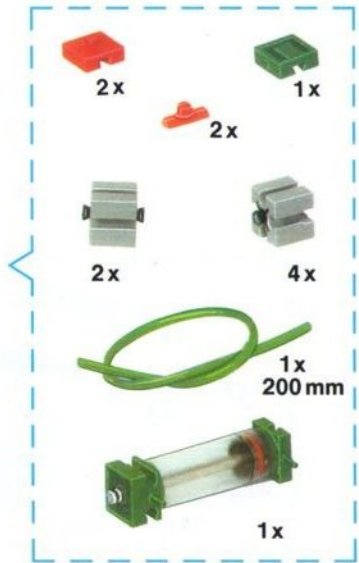
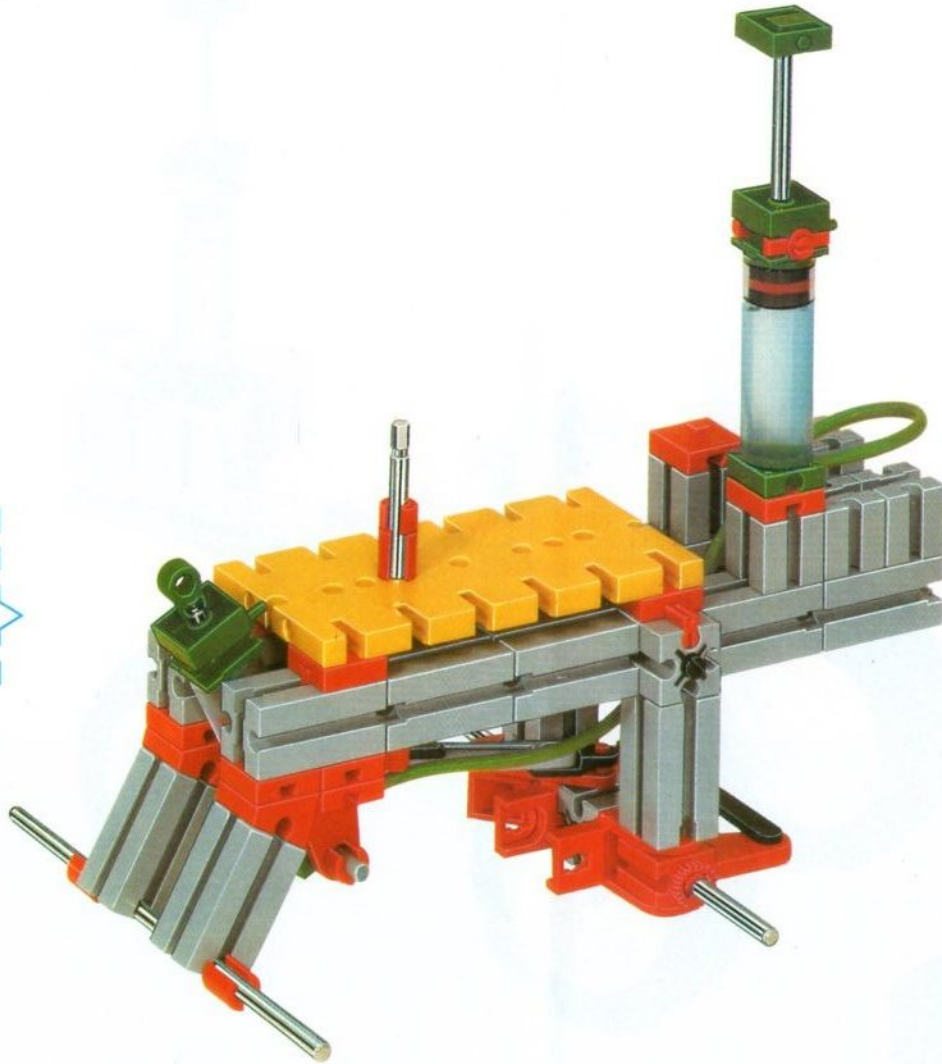
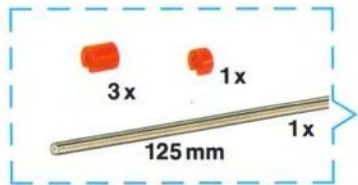



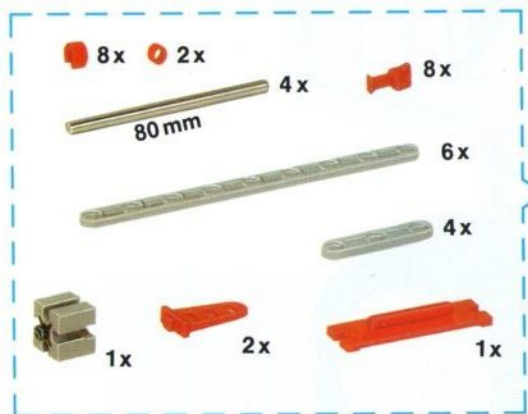

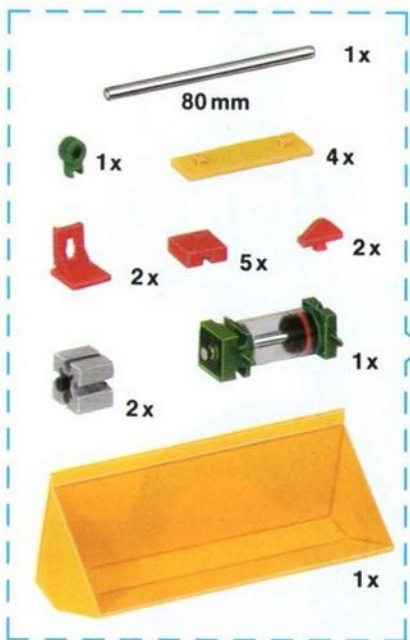

10



- 4x
- 2x
- 2x
- 2x
- 1x
- 1x



von hinten
rear view
de derrière
van achteren
por detrás
dietro

